

Art. Nr. 109924

Teilenummerierung der Spritzteile

La numération des pièces moulées

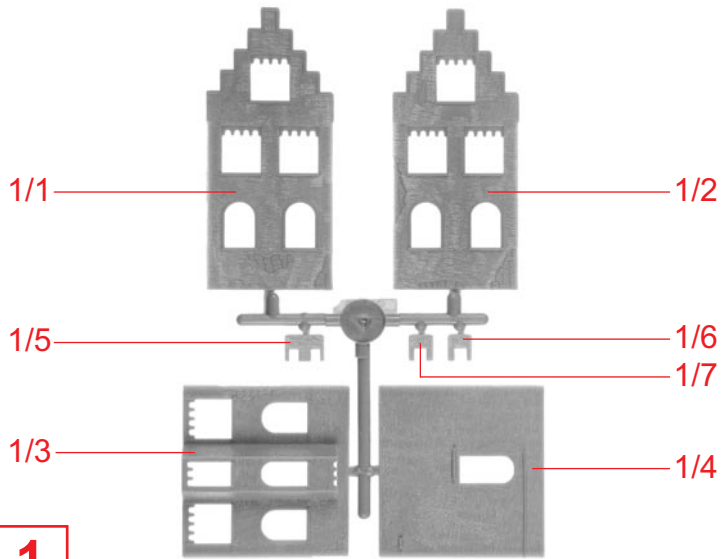

1

Part numbering of the moulded parts

Nummering van de delen van de spuitgietstukken

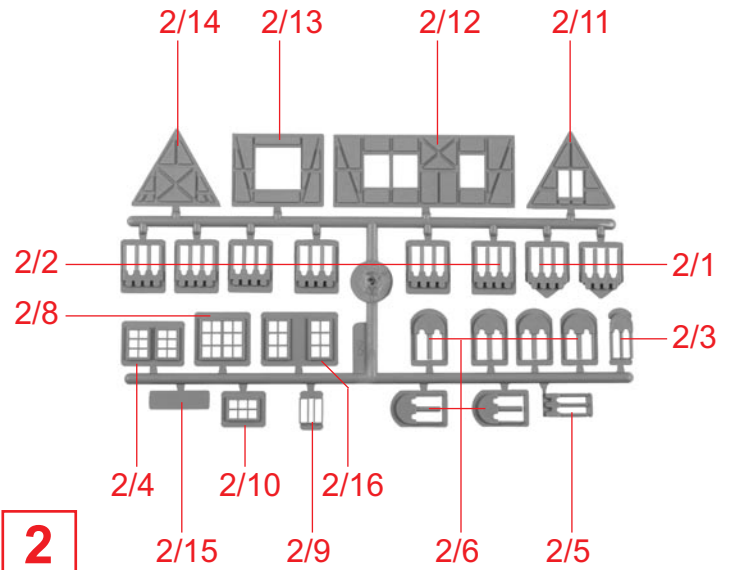

2

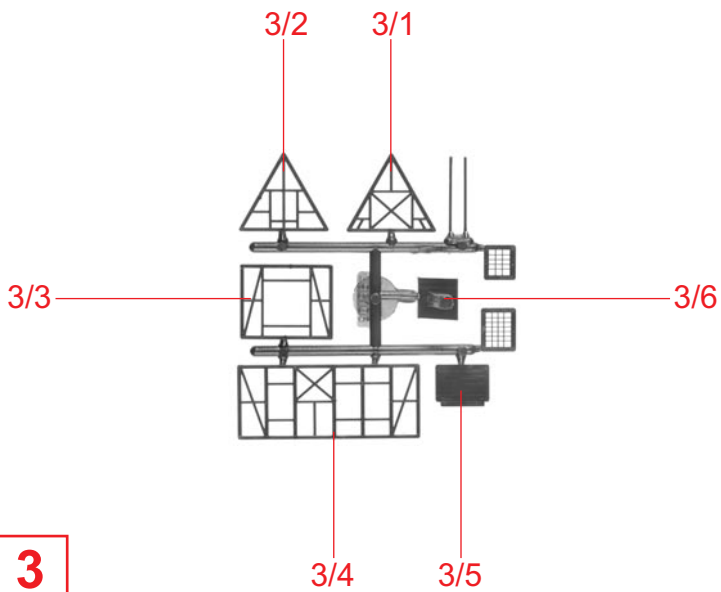

3

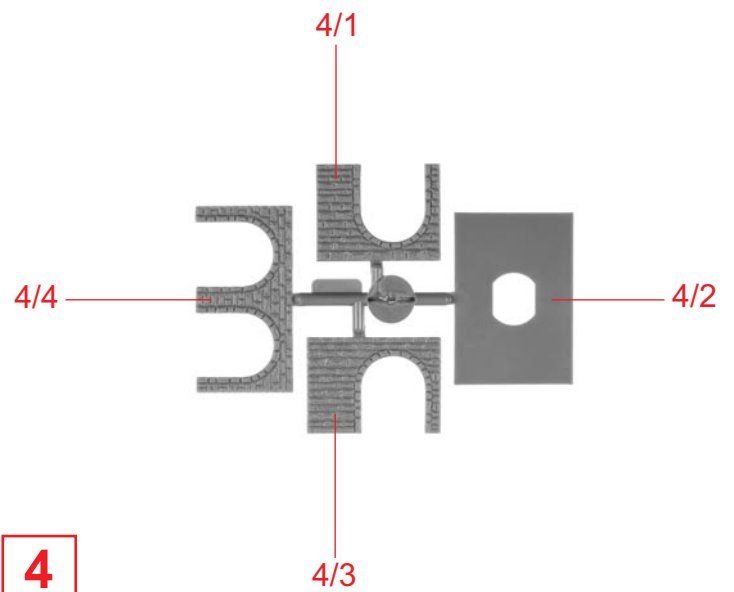

4

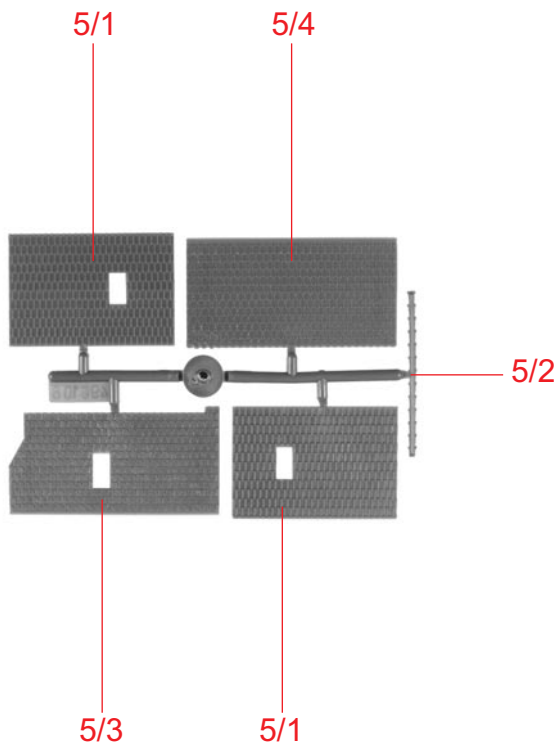

5

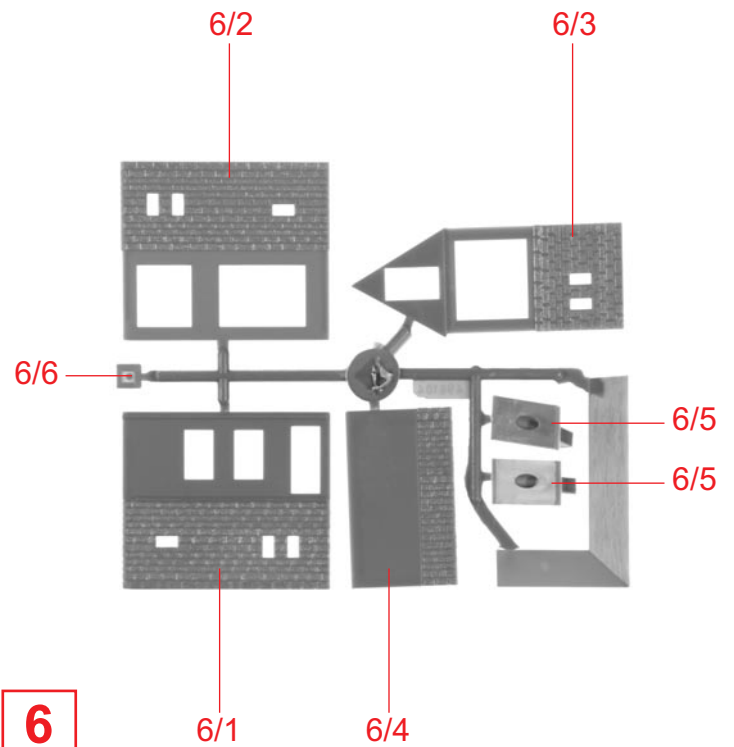

6

2

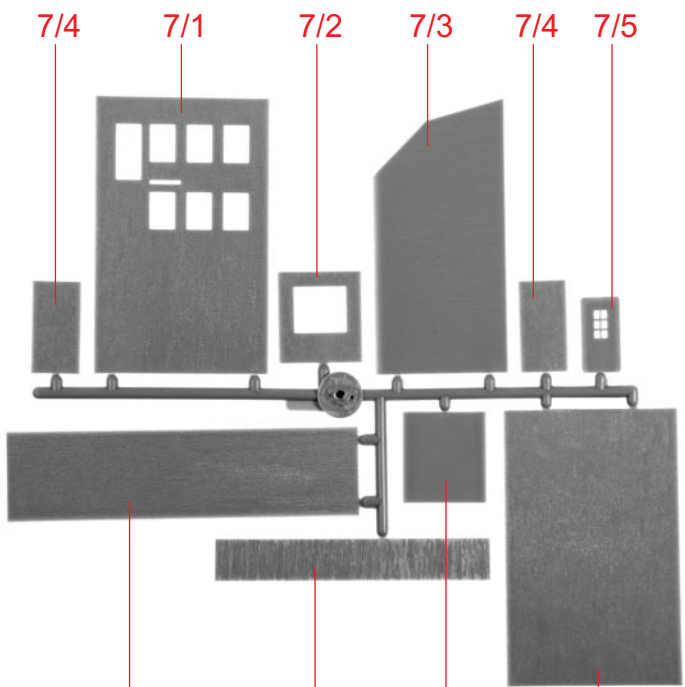

7

8/2

8/3

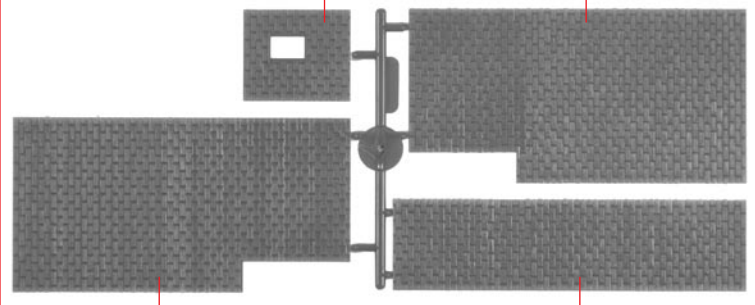

8

9/2 9/8 9/13 9/12 9/3

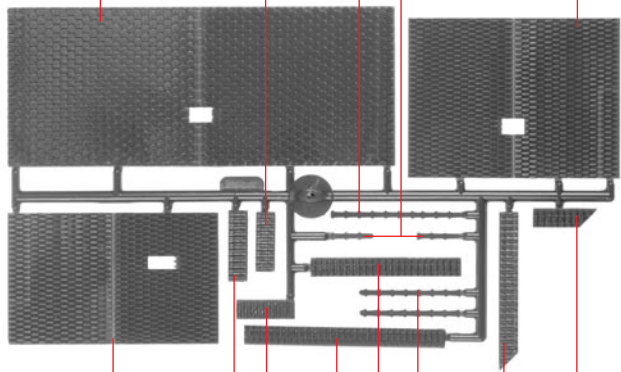

9

10/2

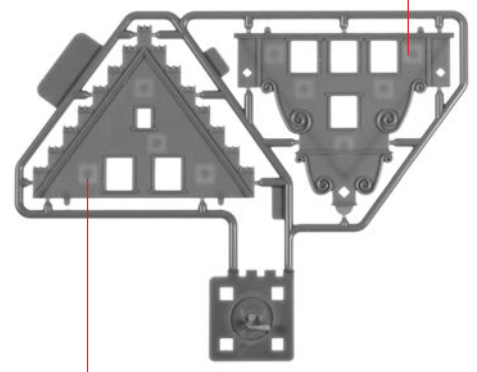

10 A

11/6 11/5 11/4 11/3 11/7 11/2

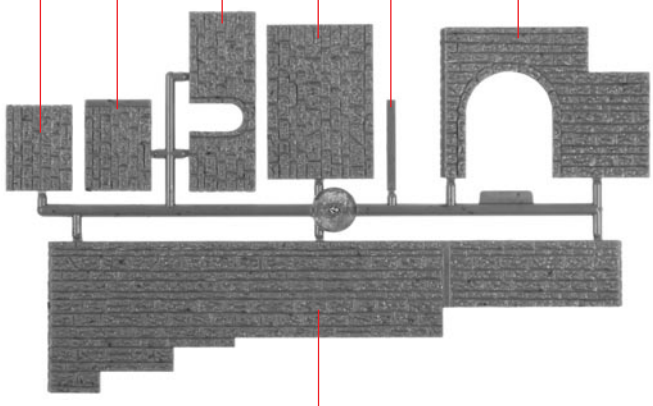

11

12/1 12/2 12/3

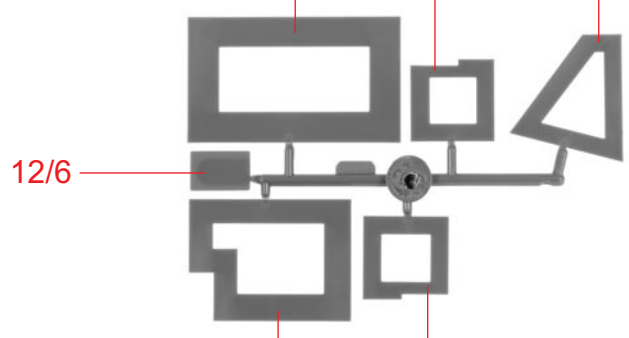

12

13/1 13/2 13/3 13/4 13/1

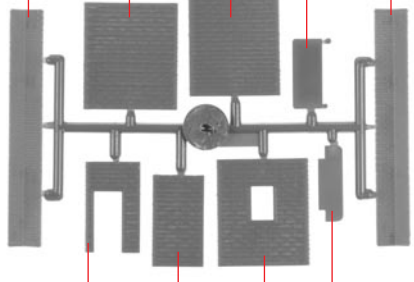

13/8 13/7 13/6 13/5

13

14/17 14/1 14/2 14/3 14/4

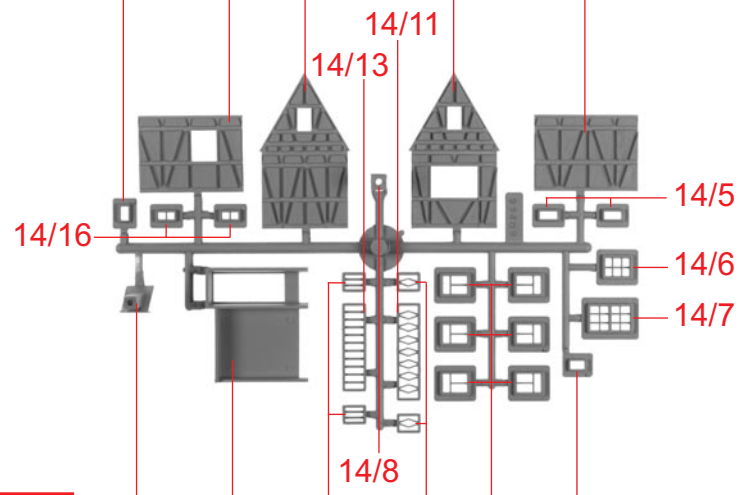

14/15 14/14 14/12 14/10 14/9 14/17

14

15/2 15/3 15/4 15/5 15/6

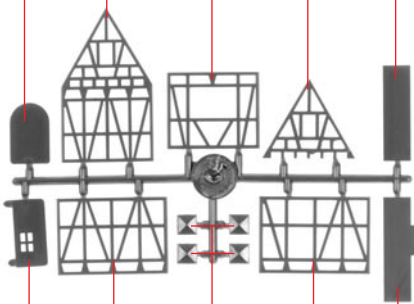

15/1 15/10 15/9 15/8 15/7

15

16/1 16/2 16/3 16/4 16/5 16/6

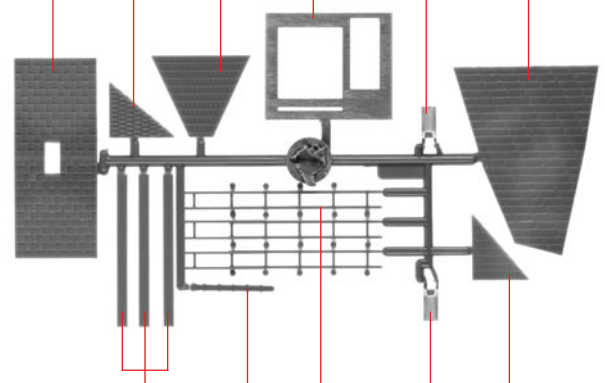

16/10 16/8 16/9 16/5 16/7

16

17/1 17/2

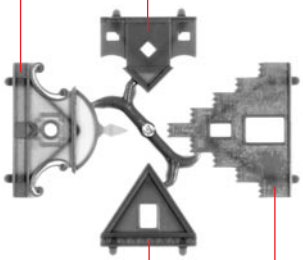

17/4 17/3

17

grau  
grey  
gris  
grijs

18/1 18/2

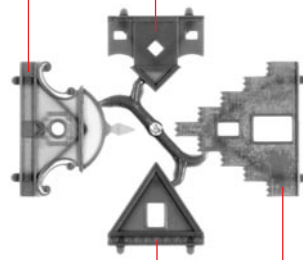

18/4 18/3

18

rosa  
pink  
rose  
roze

19/1 19/2 19/3

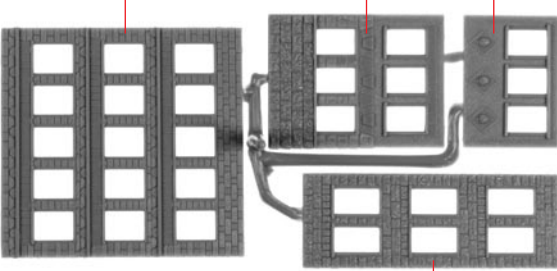

19/4

19

grau  
grey  
gris  
grijs

20/1 20/2 20/3

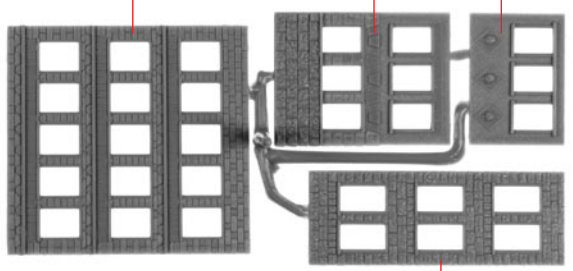

20/4

20

rosa  
pink  
rose  
roze

4

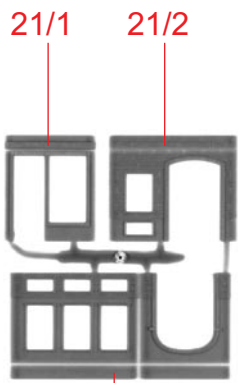

**21** 2 x 21/3

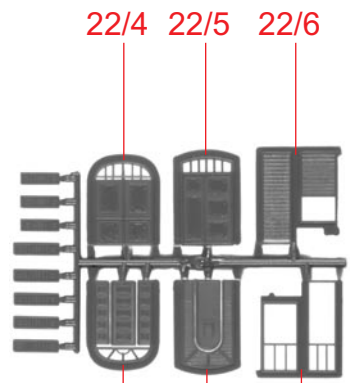

**22** 22/3 22/2 22/1

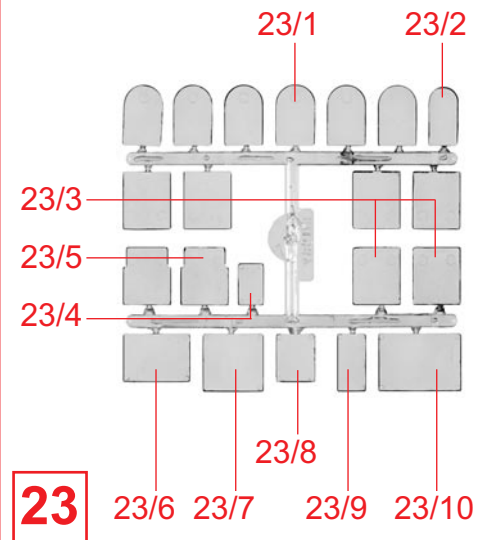

**23** 23/6 23/7 23/9 23/10

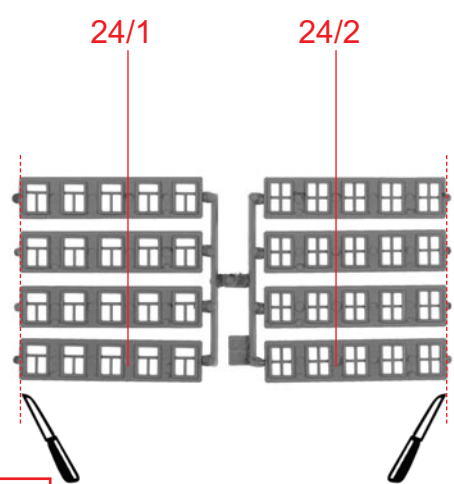

**24**

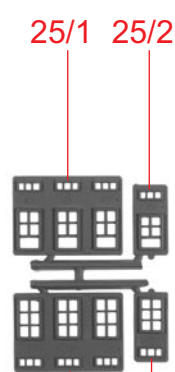

**25** 25/1 25/2

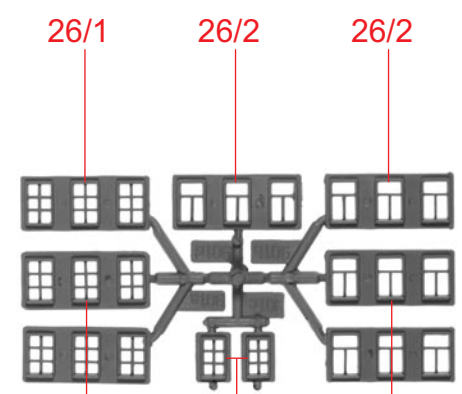

**26** 26/1 26/3 26/2

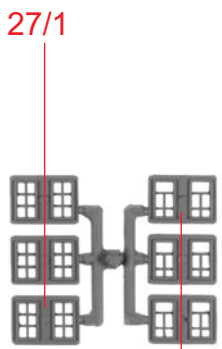

**27** 27/2

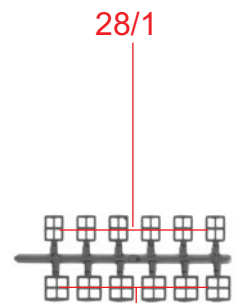

**28** 28/2

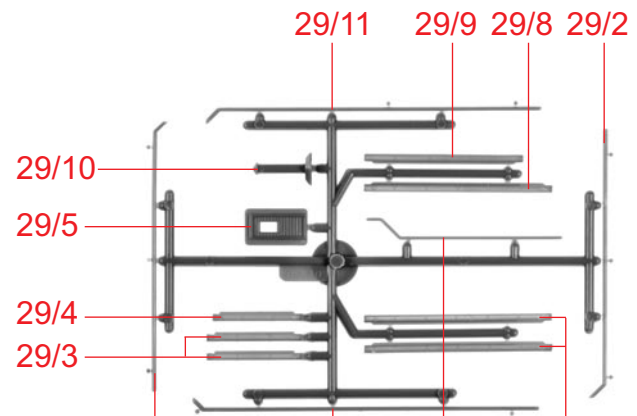

**29** 29/12 29/1 29/7 29/6

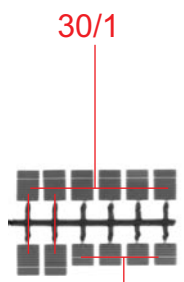

**30** 30/2

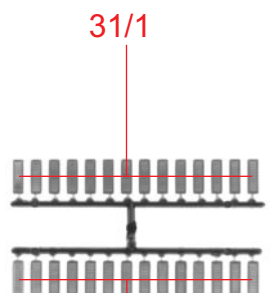

**31** 31/1

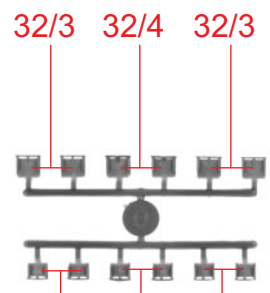

**32** 32/2 32/1

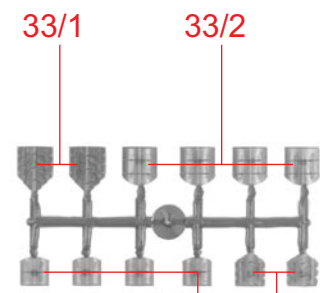

**33** 33/3 33/4

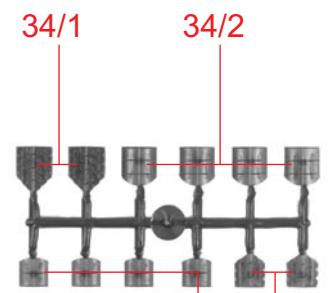

**34** 34/3 34/4

grau  
grey  
gris  
grijs

braun  
brown  
marron  
bruin